

Model 770 Fastrap Restraint System



Description

The Model 770 Fastrap Restraint System (called the Fastrap in this manual) is a system of hook-and-loop fastening straps that provides quick restraint of a patient on a horizontal transport device such as a backboard or scoop stretcher.

The Fastrap is adjustable to accommodate pediatric and adult patients. Other features include color-coded straps for easy application, and a wrist restraint.

Do not use the Fastrap to secure a patient on an ambulance cot or for vertical extrication. Use, or add, appropriate restraints rated for these situations.

General Specifications

Load Limit* 1000 lb 454 kg

Weight 2 lb 689 g

Strap Lengths

V-Strap (overall) 62 in 157 cm

V-Strap (each side) 31 in 79 cm

Chest 66 in 168 cm

Pelvic 66 in 168 cm

Thigh 66 in 168 cm

Wrist 21 in 53 cm

Foot 46 in 117 cm

General specifications are rounded to the nearest whole number. Metric conversions are calculated before rounding the Imperial measurements. For more information, contact Ferno Customer Relations (page 8).

WARNING

Improper use can cause injury. Use the Fastrap only as described in this manual.

WARNING

Exceeding the load limit can cause injury. Do not exceed the load limit of the Fastrap or the transport device.

WARNING

Using the Fastrap on an ambulance cot or for vertical extrication can cause injury or death. Use, or add, restraints and equipment specified for these purposes.



LOAD LIMIT

Inspect the Fastrap if the load limit has been exceeded.

***The load limit of the Fastrap may be higher than the load limit of the equipment it is used on. Do not exceed the load limit of the equipment.**

Safety Information

Warning

Warning notices indicate a potentially hazardous situation which, if not avoided, could result in injury or death.

WARNING

Improper use can cause injury. Use the Fastrap only as described in this manual.

Exceeding the load limit can cause injury. Do not exceed the load limit of the Fastrap or the transport device.

Using the Fastrap on an ambulance cot or for vertical extrication can cause injury or death. Use, or add, restraints and equipment specified for these purposes.

Untrained operators can cause injury or be injured. Permit only trained personnel to apply the Fastrap.

Improper restraint of the patient can cause injury. Follow approved emergency patient-handling procedures when using the Fastrap.

Improper maintenance can cause injury. Maintain the Fastrap only as described in this manual.

Important

Important notices emphasize important usage or maintenance information.

Important

Disinfectants and cleaners containing bleach, phenolics, or iodines can damage the Fastrap. Disinfect and clean only with products that do not contain these chemicals.

Bloodborne Disease Notice

To reduce the risk of exposure to bloodborne diseases such as HIV-1 and hepatitis when using the Fastrap, follow the disinfecting and cleaning instructions in this manual.

Operator Skills and Training

Skills

Operators must:

- be trained in emergency care procedures.
- have the ability to assist the patient.
- have a complete understanding of the procedures described in this manual.

WARNING

Untrained operators can cause injury or be injured. Permit only trained personnel to apply the Fastrap.

Training

Trainees need to:

- follow a training plan designed by their training officer.
- read this manual. For additional free users' manuals, contact your Ferno distributor or Ferno Customer Relations (page 8).
- practice using the Fastrap before using it in regular service.
- be tested on their understanding of the Fastrap.
- record their training information and keep records.

Components

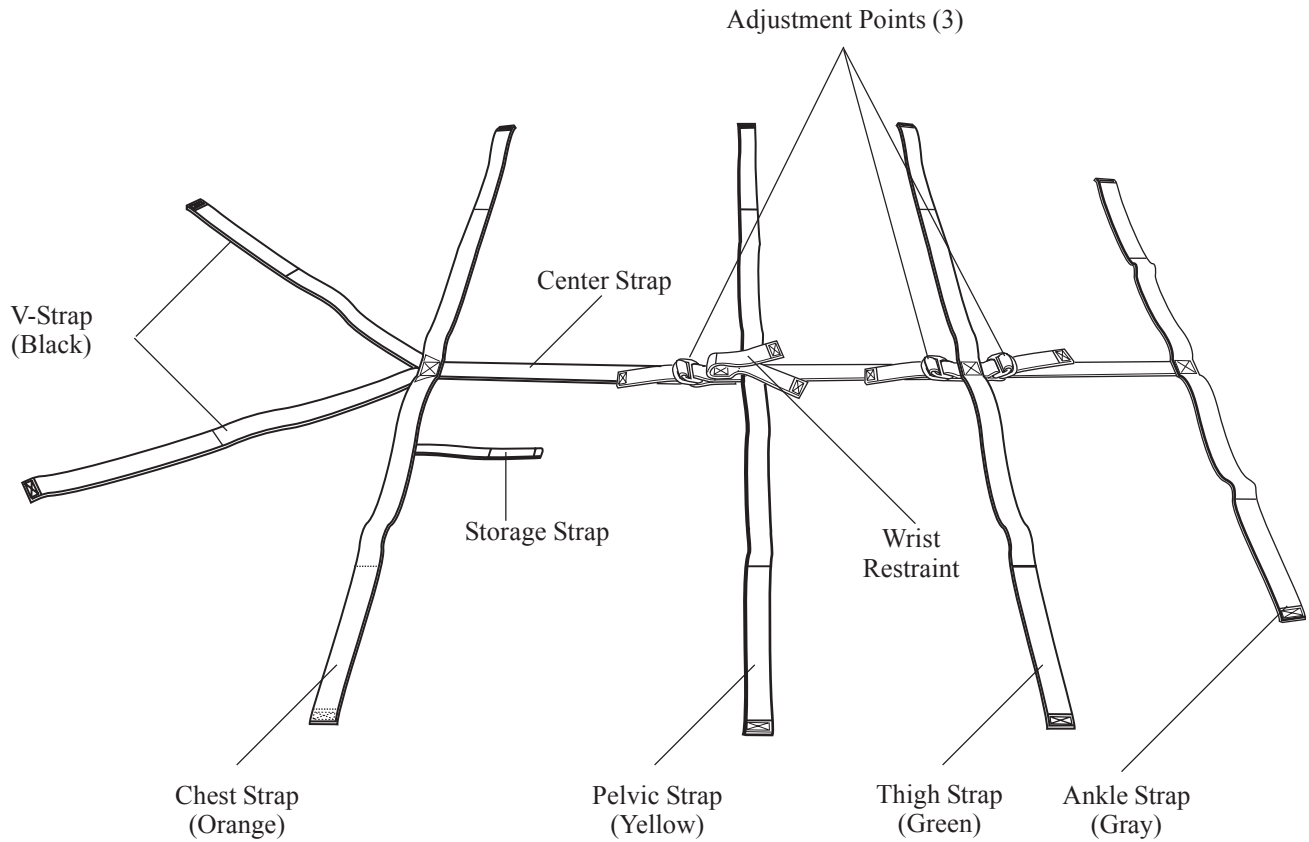

Using the Fastrap

Operating Guidelines

- The Fastrap is for professional use only.
- Use the Fastrap only as described in this manual.
- Use the Fastrap only when it is in good condition.
- Practice using the Fastrap before placing it in service.
- Follow approved emergency patient-handling procedures to properly secure and transport the patient.

WARNING

Improper use can cause injury. Use the Fastrap only as described in this manual.

WARNING

Improper restraint of the patient can cause injury. Follow approved emergency patient-handling procedures when using the Fastrap.

Using the Fastrap

UNFOLDING THE FASTRAP

Pull the storage strap open and lay the straps down (Figure 1). Before applying the Fastrap, follow approved emergency patient-handling procedures and your local protocols to place the patient on the transport device.

APPLYING THE FASTRAP

Lay the Fastrap, pile side up, along the center of the patient's body with the straps positioned across the patient as shown in Figure 2. Adjust the length of the Fastrap as needed to fit the patient, then secure the patient on the transport device.

- **Black V-strap:** over the shoulders
- **Orange chest strap:** across the chest
- **Yellow pelvic strap:** across the pelvis
- **Green thigh strap:** above the knees
- **Gray ankle strap:** near the ankles

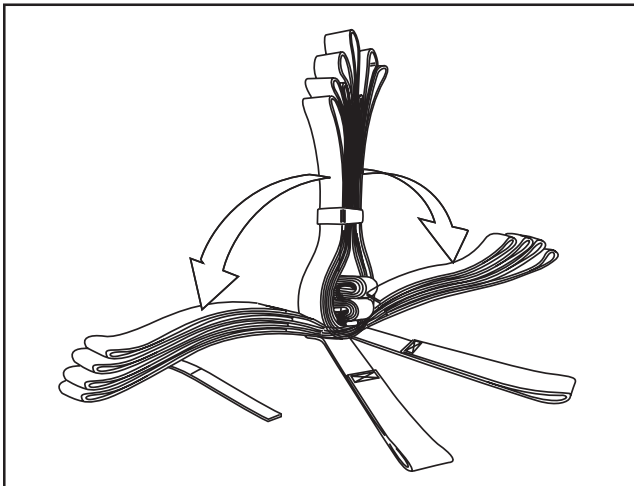

Figure 1 - Unfolding the Fastrap

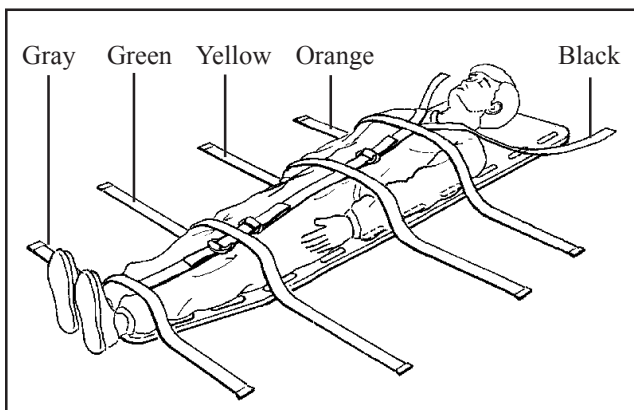

Figure 2 - Applying the Fastrap

ADJUSTING THE LENGTH OF THE FASTRAP

The Fastrap has three adjustment points along the center strap. Use these adjustment points to properly size the Fastrap for the patient.

The adjustment points are located between the chest and pelvic straps, between the pelvic and thigh straps, and between the thigh and ankle straps.

To lengthen the center strap: select an adjustment point and lift the top D-ring. Pull the center strap through both D-rings as shown in Figure 3. If the tab pulls free of the rings, use Figure 3 as a guide to thread the strap through the D-rings.

To shorten the center strap : lift the top D-ring and pull the tab through the D-rings as shown in Figure 4.

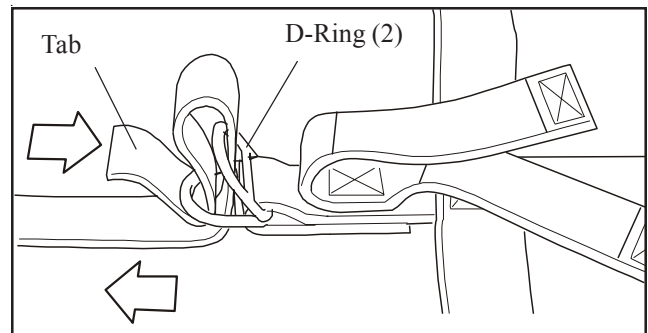

Figure 3 - Lengthening the Center Strap

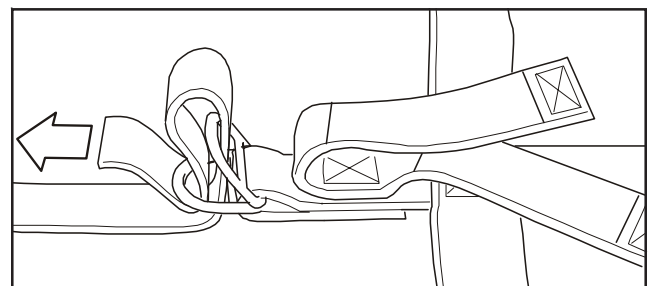

Figure 4 - Shortening the Center Strap

Using the Fastrap

SECURING THE PATIENT

Keep the center strap centered on the patient's body as you secure the patient with the Fastrap.

1. To secure each strap, feed it through a handhold or other fastening point on the transport device, bring the strap around the fastening point and press the strap onto itself to secure the hook-and-loop fastening material (Figure 5).
3. Secure the patient's wrists in one of two ways:
 - At his/her side, using the pelvic strap (Figure 6).
 - On top of the pelvis, using the wrist restraint (Figure 7).
4. Snug the V-strap across the patient's shoulders. As needed, place padding (rolled blankets, towels, etc.) to fill gaps between the shoulders and straps (Figure 8).
5. Follow approved emergency patient-handling procedures to lift and transport the patient in a **horizontal position only**. Do not use the Fastrap to secure a patient on an ambulance cot or for vertical extrication. Use, or add, restraints and equipment specified for these purposes.

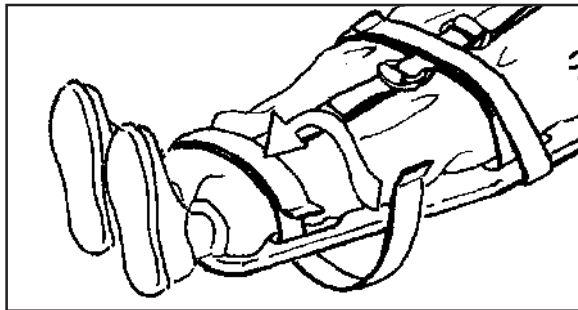

Figure 5 - Securing a Strap

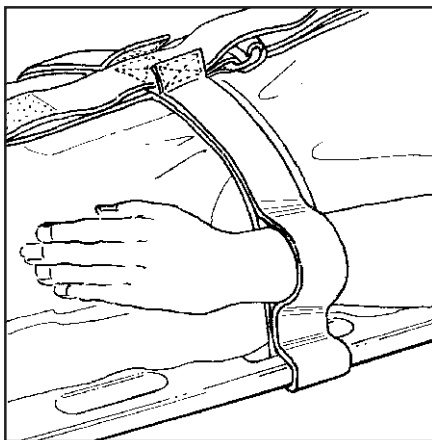

Figure 6 - Wrists Secured by Pelvic Strap

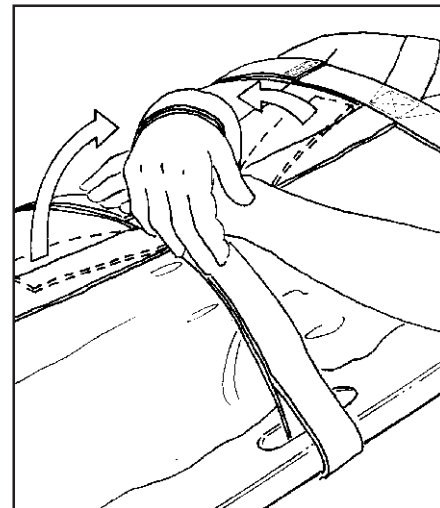

Figure 7 - Wrists Secured by Wrist Restraints

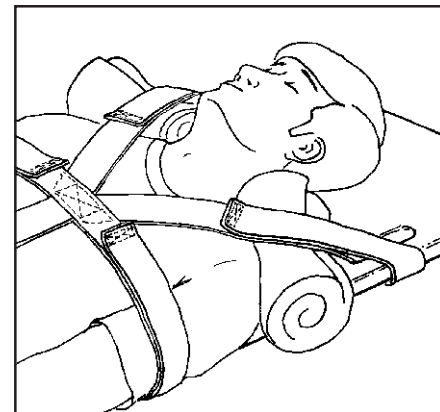

Figure 8 - Filling Gaps Between Patient's Shoulders and V-Straps

WARNING

Improper restraint of the patient can cause injury. Follow approved emergency patient-handling procedures when using the Fastrap.

WARNING

Using the Fastrap on an ambulance cot or for vertical extrication can cause injury or death. Use, or add, restraints and equipment specified for these purposes.

Using the Fastrap

STORING THE FASTRAP

Disinfect, clean and allow the Fastrap to dry before storing it (see *Maintenance*, page 7). To fold the Fastrap for storage:

1. Lay the Fastrap on a flat surface.
2. Fold each half strap to the center and press it to itself to engage the hook-and-loop fastening material.
3. Stack the gray ankle strap on the green thigh strap (Figure 9).
4. Stack the ankle and thigh straps on the yellow pelvic strap (Figure 10).
5. Stack the ankle, thigh, and pelvic straps on the orange chest strap (Figure 11).
6. Lift the body straps and the black V-straps until they meet above the center of the Fastrap (Figure 12). Secure the straps with the storage strap.
7. Store the Fastrap in a dry place.

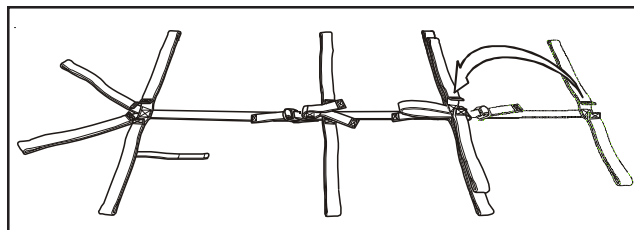

Figure 9 - Folding the Foot Strap

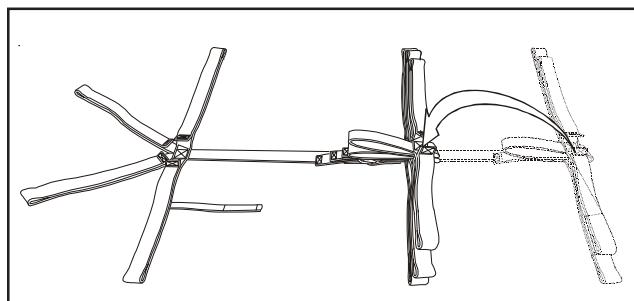

Figure 10 - Making the Second Fold

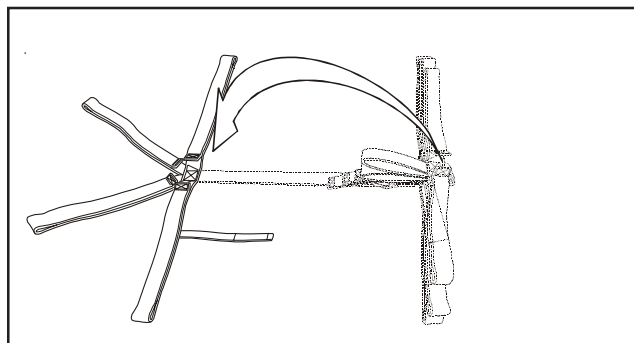

Figure 11 - Making the Third Fold

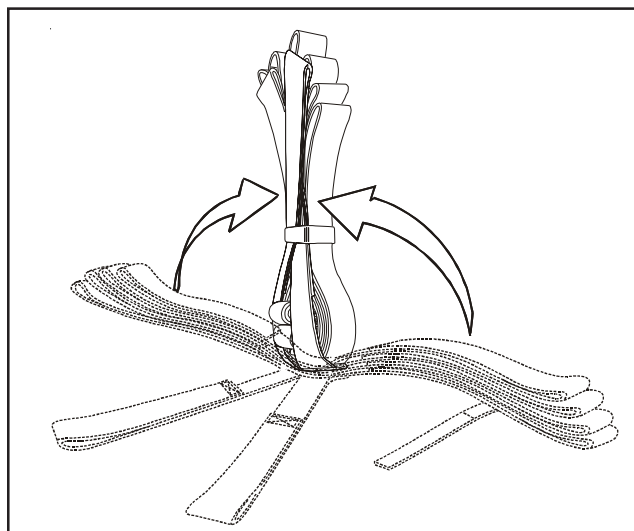

Figure 12 - Final Folds

Maintenance Schedule

The Fastrap requires regular maintenance. Set up and follow a maintenance schedule. The chart at right represents minimum maintenance.

When using maintenance products, follow the manufacturers' directions and read the manufacturers' material safety data sheets.

MAINTENANCE SCHEDULE	Each Use	As Needed	Each Month
Disinfecting	•		
Cleaning		•	
Inspecting		•	•

Disinfecting and Cleaning

Remove the Fastrap from equipment before cleaning or disinfecting it.

To disinfect: Apply disinfectant to all surfaces, following the manufacturer's instructions for application method and contact time. Ferno recommends that you inspect the Fastrap for obvious damage as you disinfect it.

To clean: Place the Fastrap inside a pillowcase. Machine wash with cold water and a mild detergent.

Hang the Fastrap and allow it to air dry before folding or storing it. Do not machine dry the Fastrap.

Inspecting

Check the hook-and-loop fastening material for lint and other debris that can decrease the fastening material's effectiveness.

Inspect the Fastrap for damage as needed, but at minimum once per month. Look for torn or frayed straps, broken D-rings, and damaged hook-and-loop material.

If inspection shows damage or excessive wear, remove the Fastrap from service and replace.

WARNING

Improper maintenance can cause injury. Maintain the Fastrap only as described in this manual.

Important

Disinfectants and cleaners containing bleach, phenolics, or iodines can damage the Fastrap. Disinfect and clean only with products that do not contain these chemicals.

Important

Machine drying can shrink or damage the Fastrap. Allow the Fastrap to air dry.

Accessories

Ferno offers a full line of products for the healthcare professional. Contact Ferno Customer Relations (below) to order related products.

Some products of interest to users of the Fastrap are listed at right.

Model 65, 65-PIN Scoop Scoop Stretchers
Scoop™ EXL Polymer Scoop Stretcher
Scoop™ EXL with pins Polymer Scoop Stretcher
Model 49 WizLoc® Disposable Collar
Model 445 Head Immobilizer
Model 455 HeadHugger Disposable Head Immobilizer
Series 740/750 Wooden Backboards
2001 Millennia™ 16" and 18" Plastic Backboards
Multiple options NAJO by Ferno Backboards

Ferno Customer Relations

Customer service and product support are important aspects of each Ferno product. For assistance, please contact Ferno Customer Relations:

Telephone (Toll-free) 1.877.733.0911
Telephone +1.937.382.1451
Fax (Toll-free) 1.888.388.1349
Fax +1.937.382.6569
Internet www.ferno.com

Ferno-Washington, Inc.
70 Weil Way
Wilmington, Ohio 45177-9371
U.S.A.

Limited Warranty Statement

The products sold by Ferno are covered by a limited warranty. The actual terms and conditions of the limited warranty, and the limitations of liability and disclaimers, are available upon request by calling 1.800.733.3766 or 1.937.382.1451.